

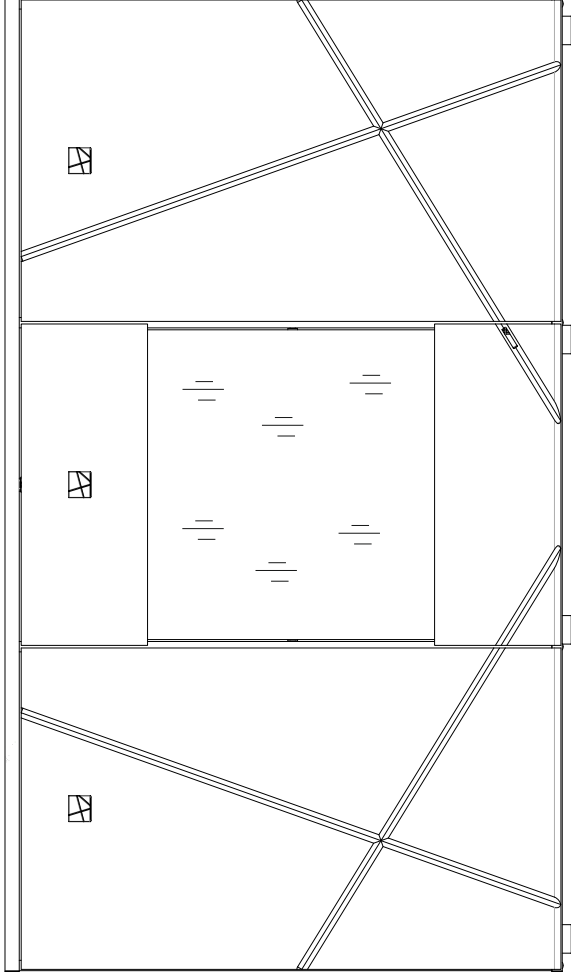

# A



90 min 



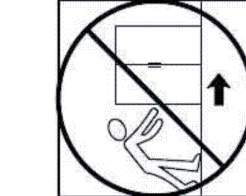
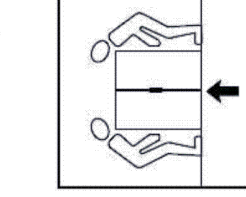
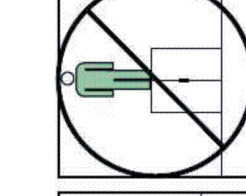
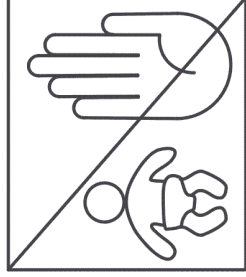
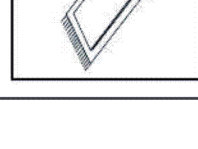
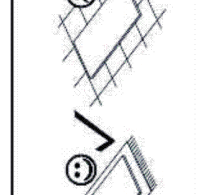
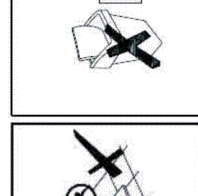
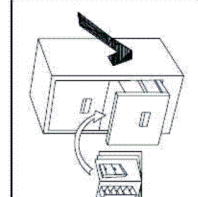
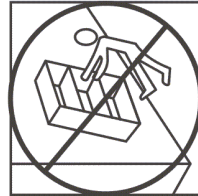
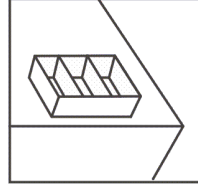
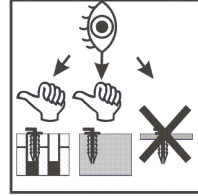
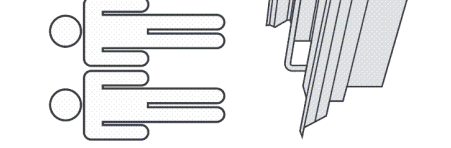
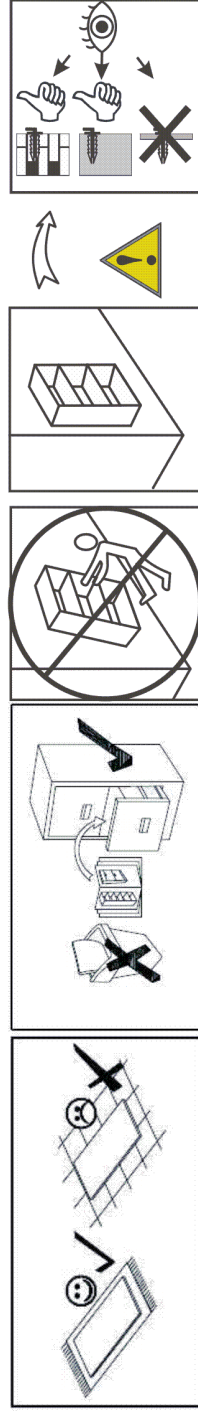
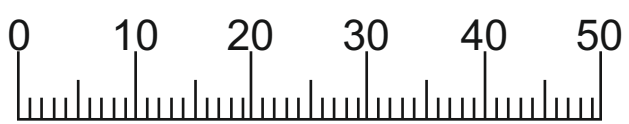
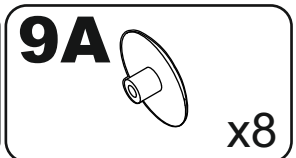
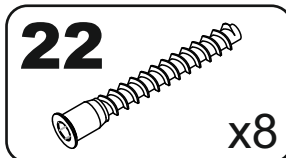
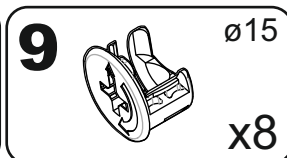
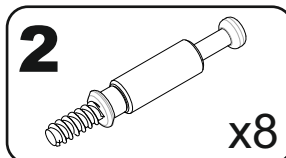
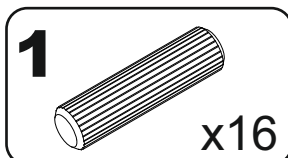
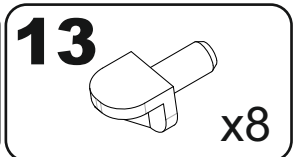
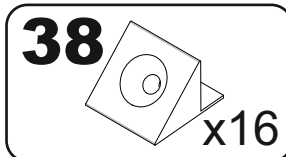
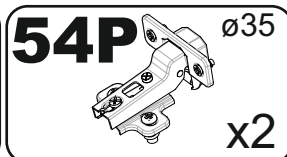
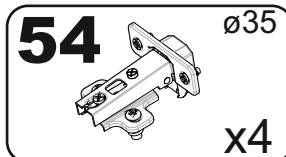
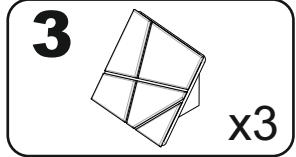
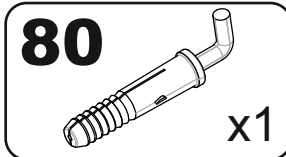
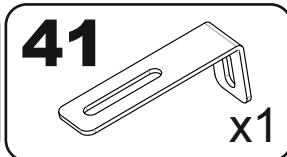
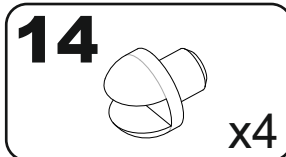
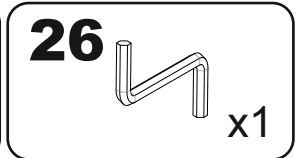
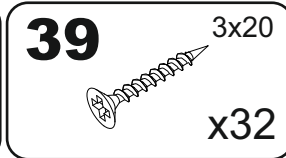
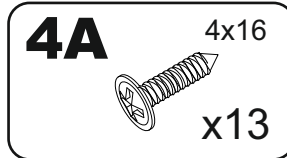
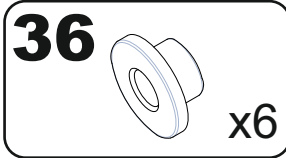
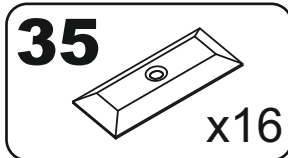
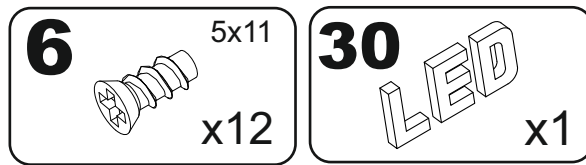
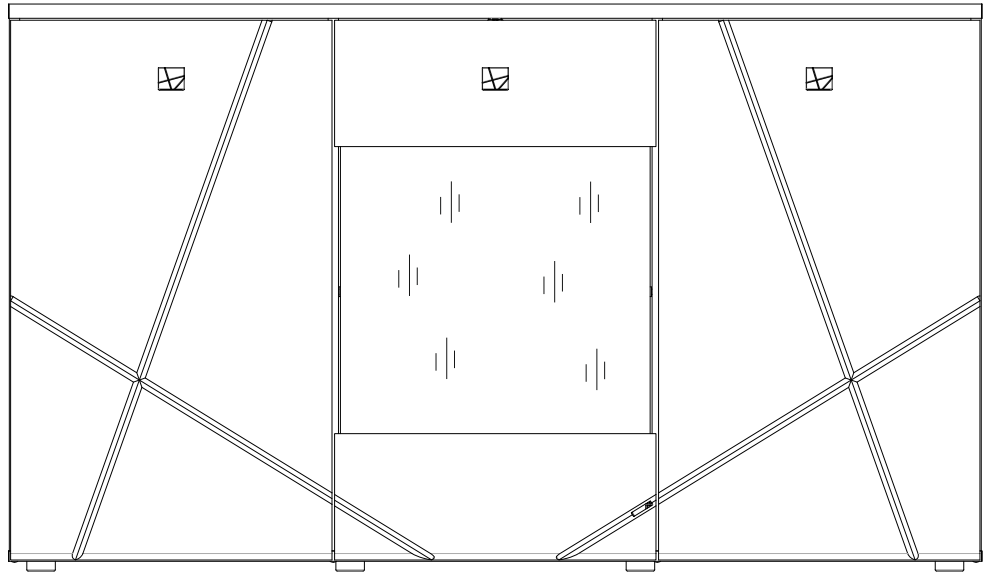
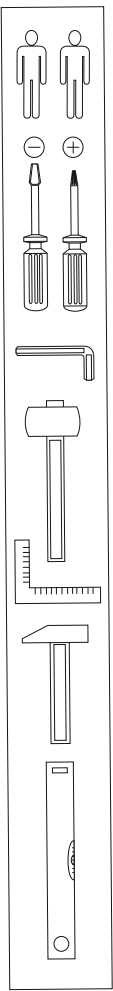

# A

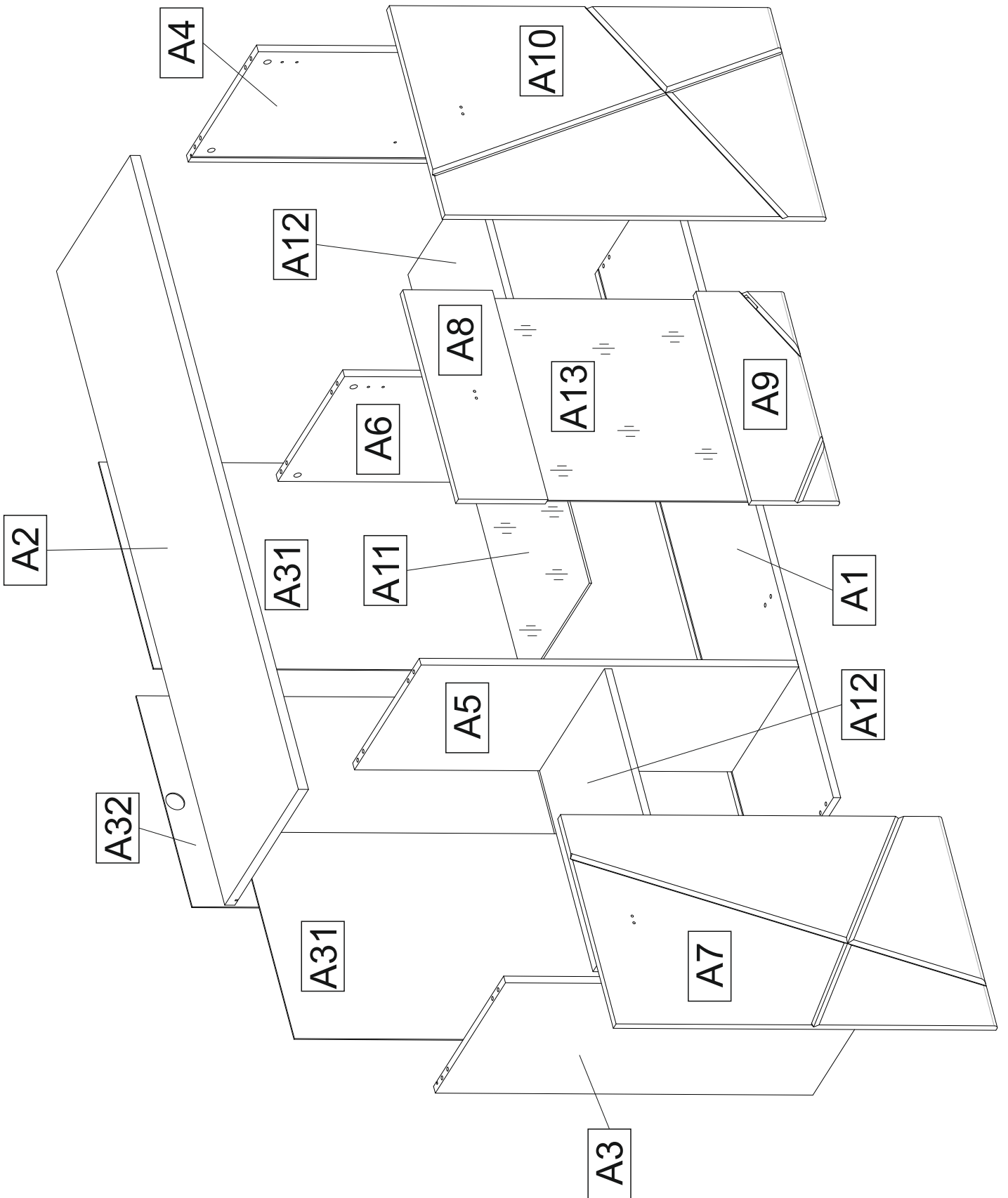

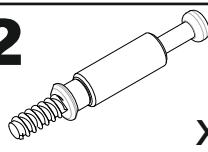
**1****2**

x8

A2

1502x420

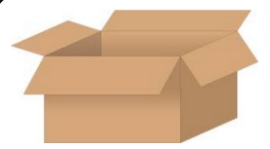

Colli nr 2

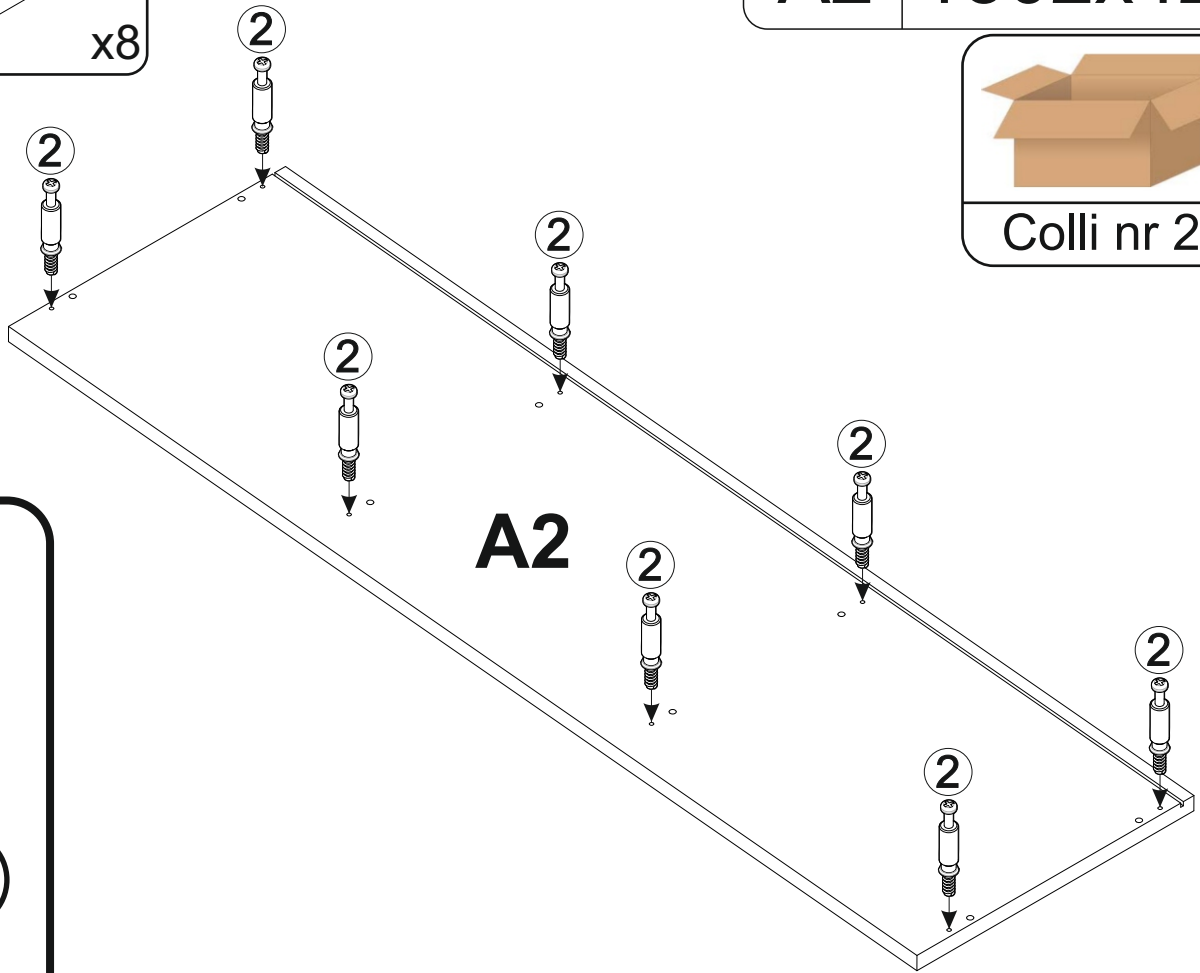
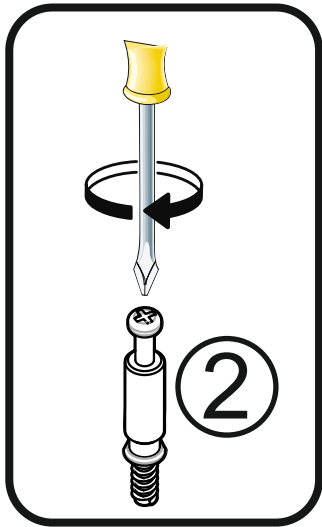
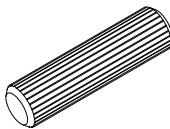
**A2****2****1**

x4

**9**

ø15

x2

**54**

ø35

x2

A3

822x400

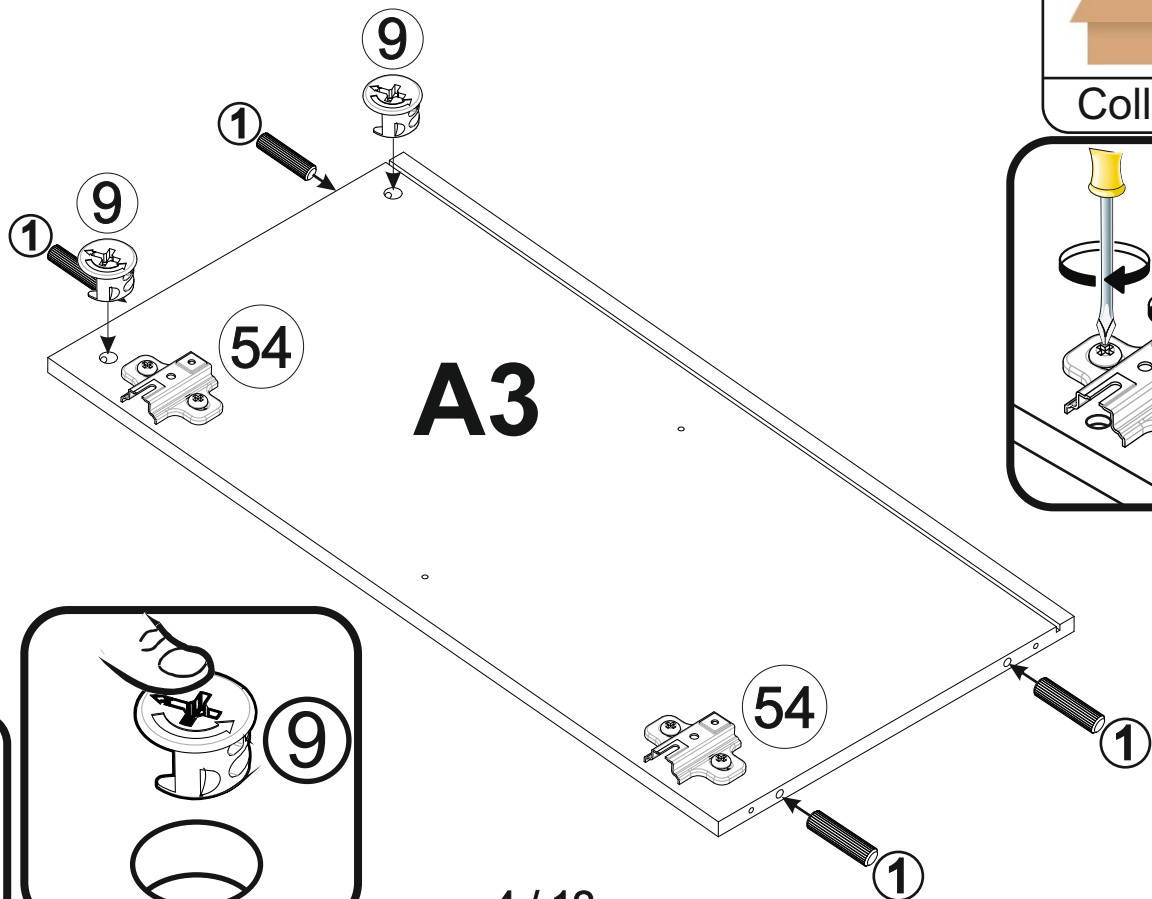
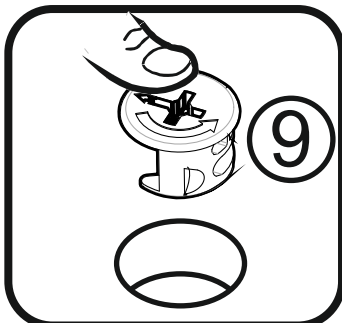
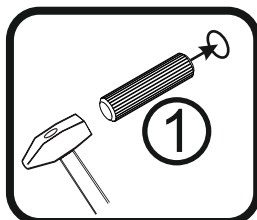
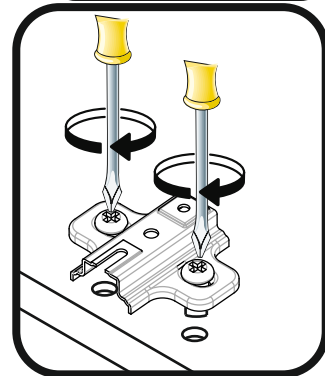

Colli nr 2

**A3**

**3**

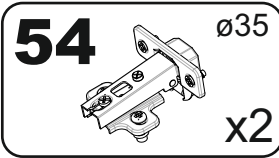
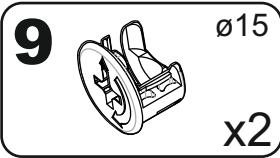
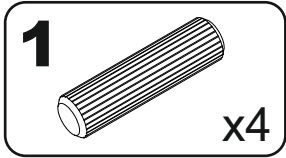

**A4** 822x400

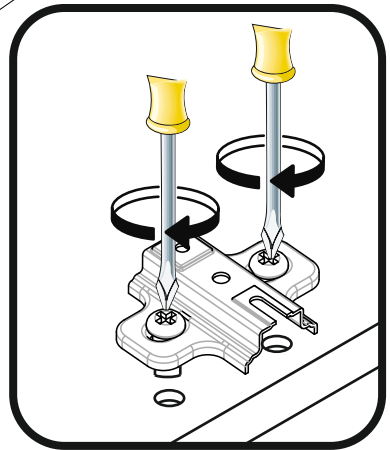
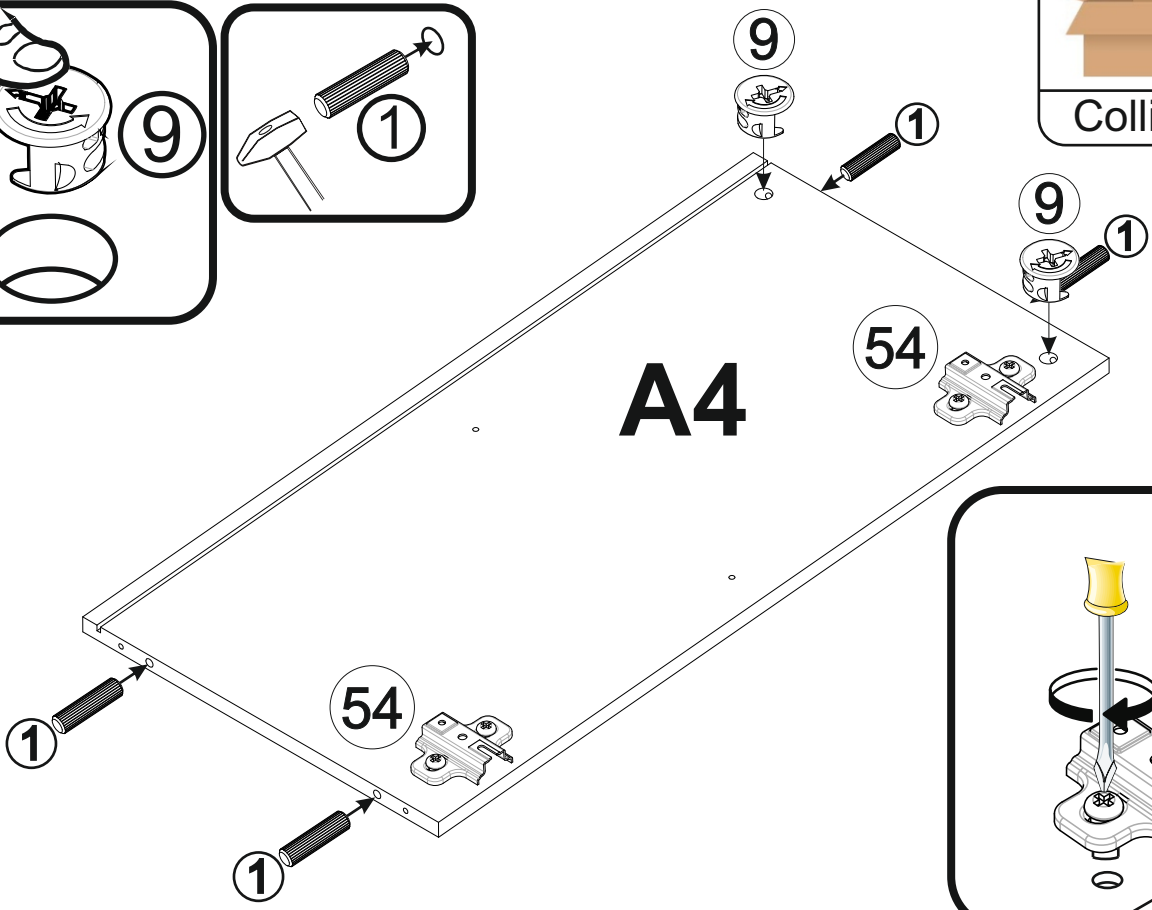
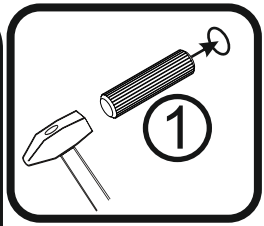
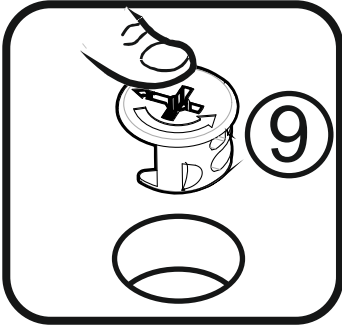
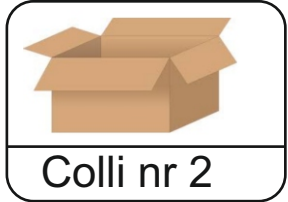

**4**

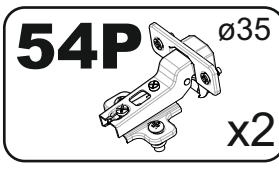
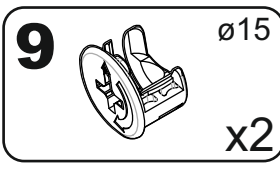
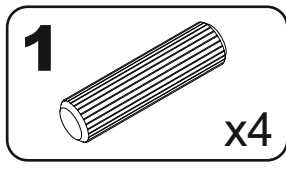

**A4** 822x380

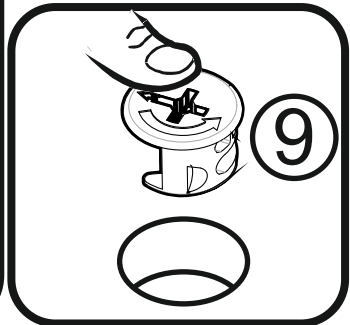
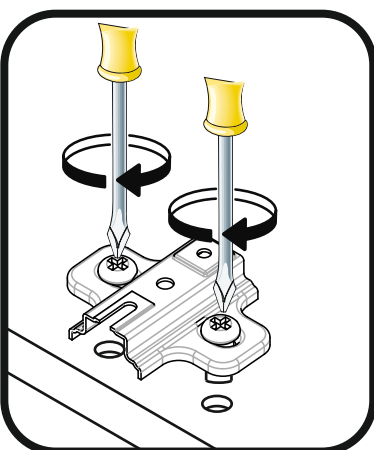
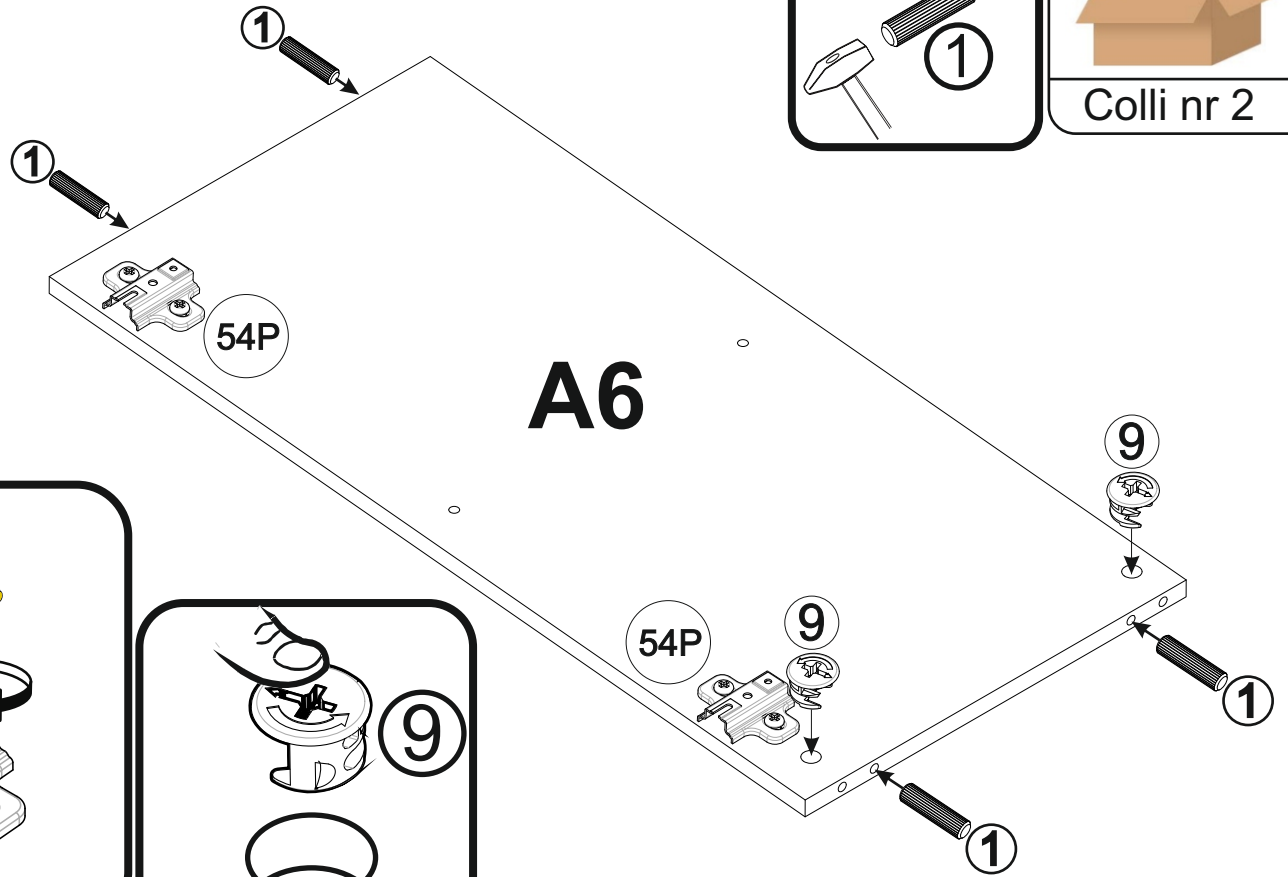
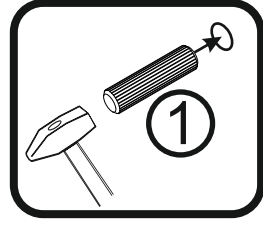
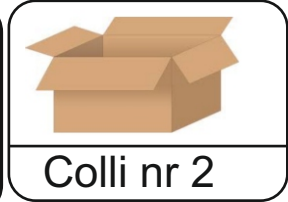

**5**

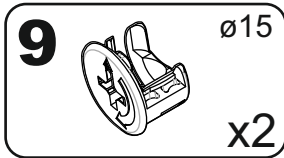
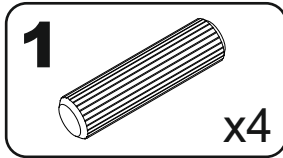

**A4**

**822x380**

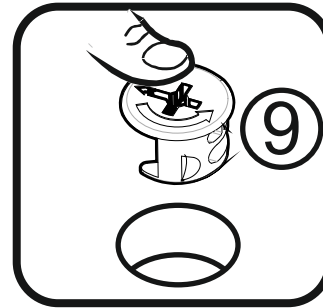
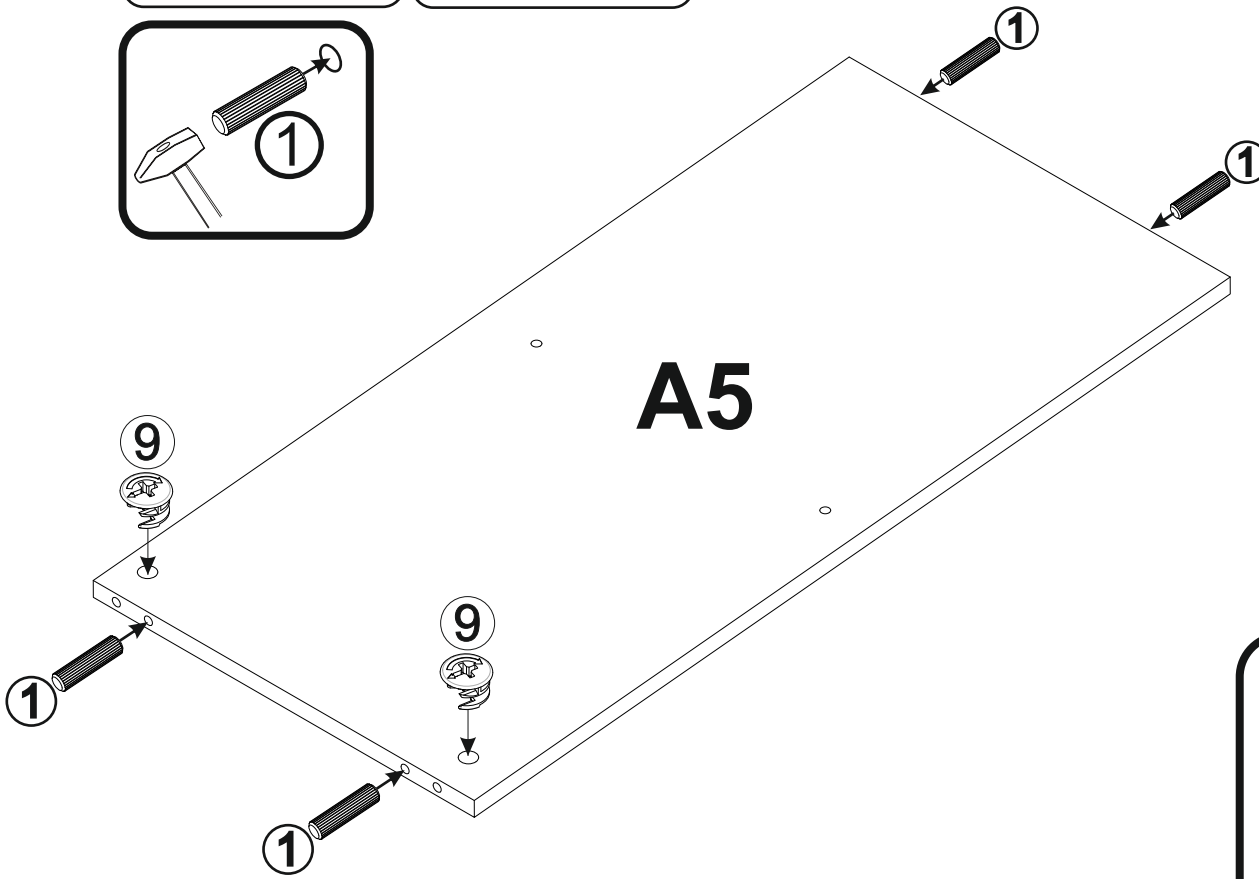
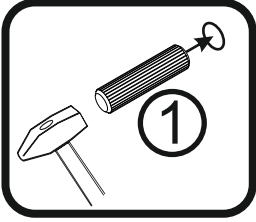
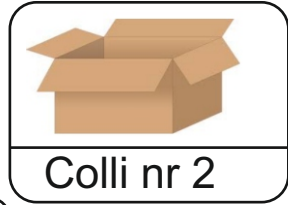

**6**

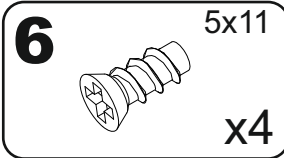
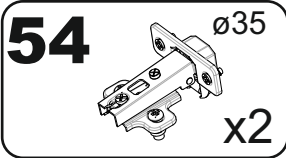

**A7**

**833x496**

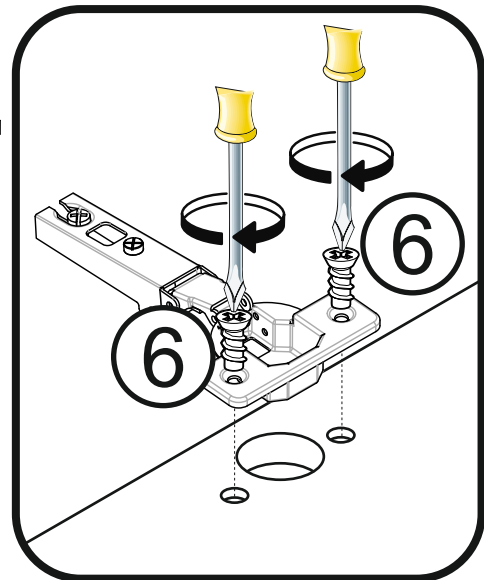
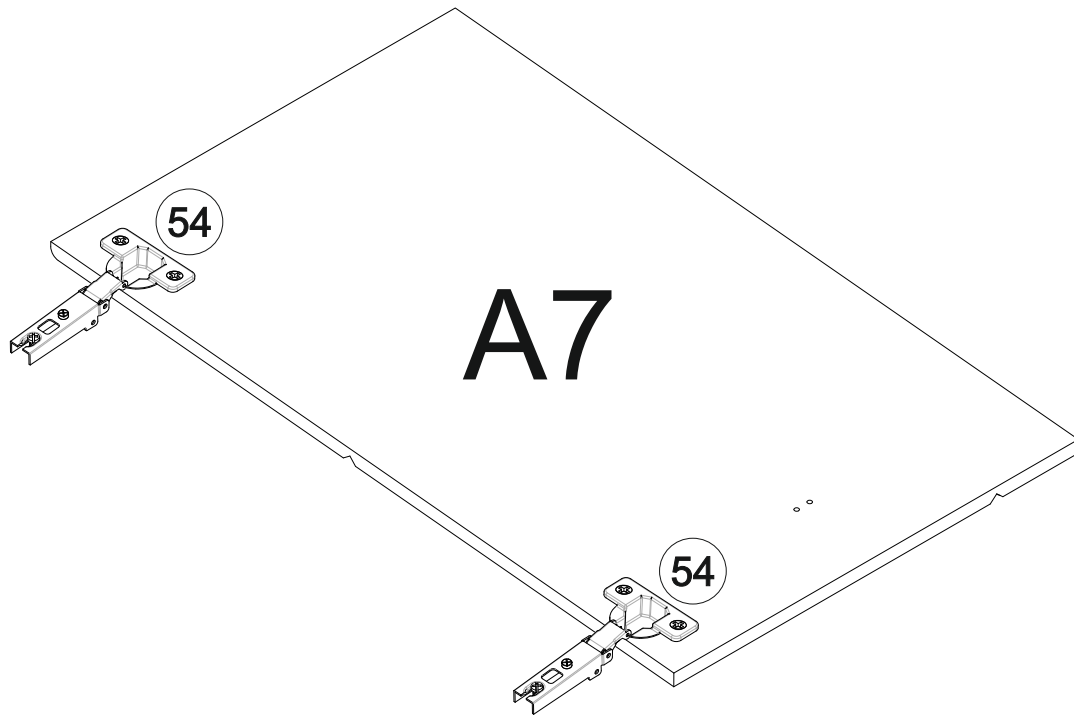
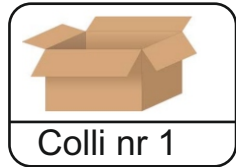

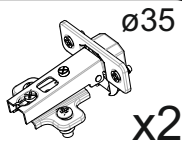
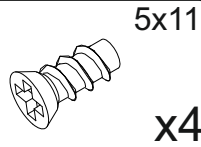
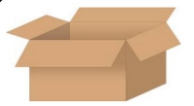
**7****54****6****A7****833x496**

Colli nr 1

**A10**

54

54

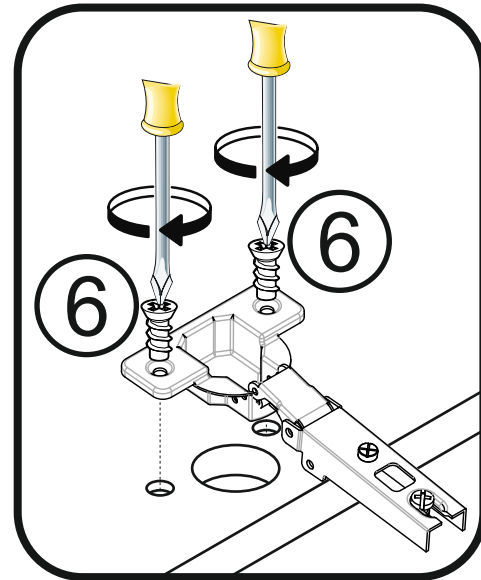
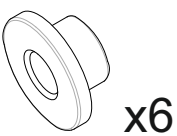
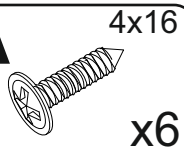
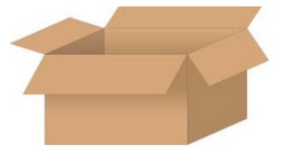
**8****36****4A****A8****496x195****A9****496x195****A13****503x478**

Colli nr 1

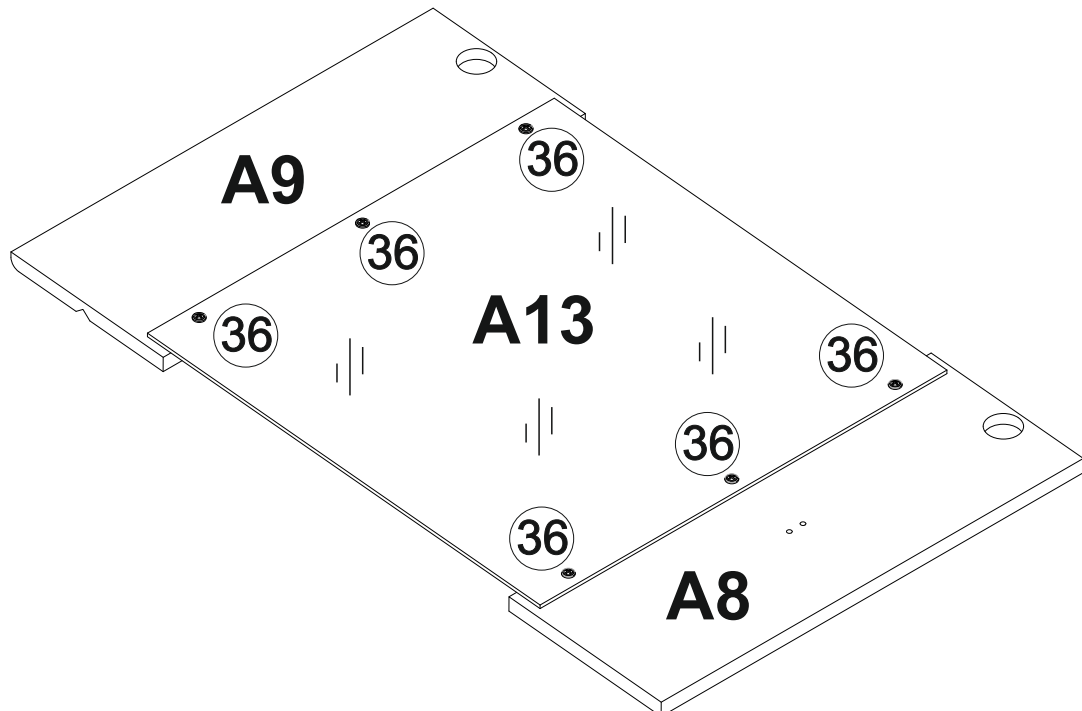
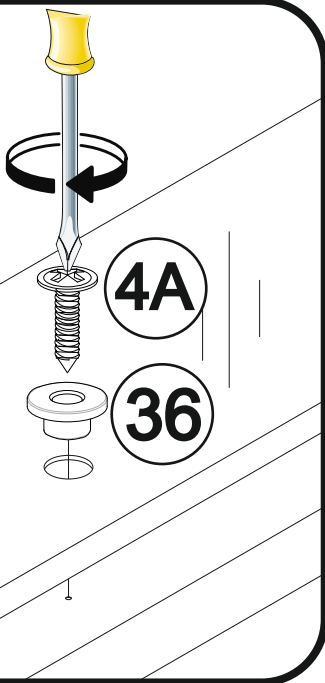



9

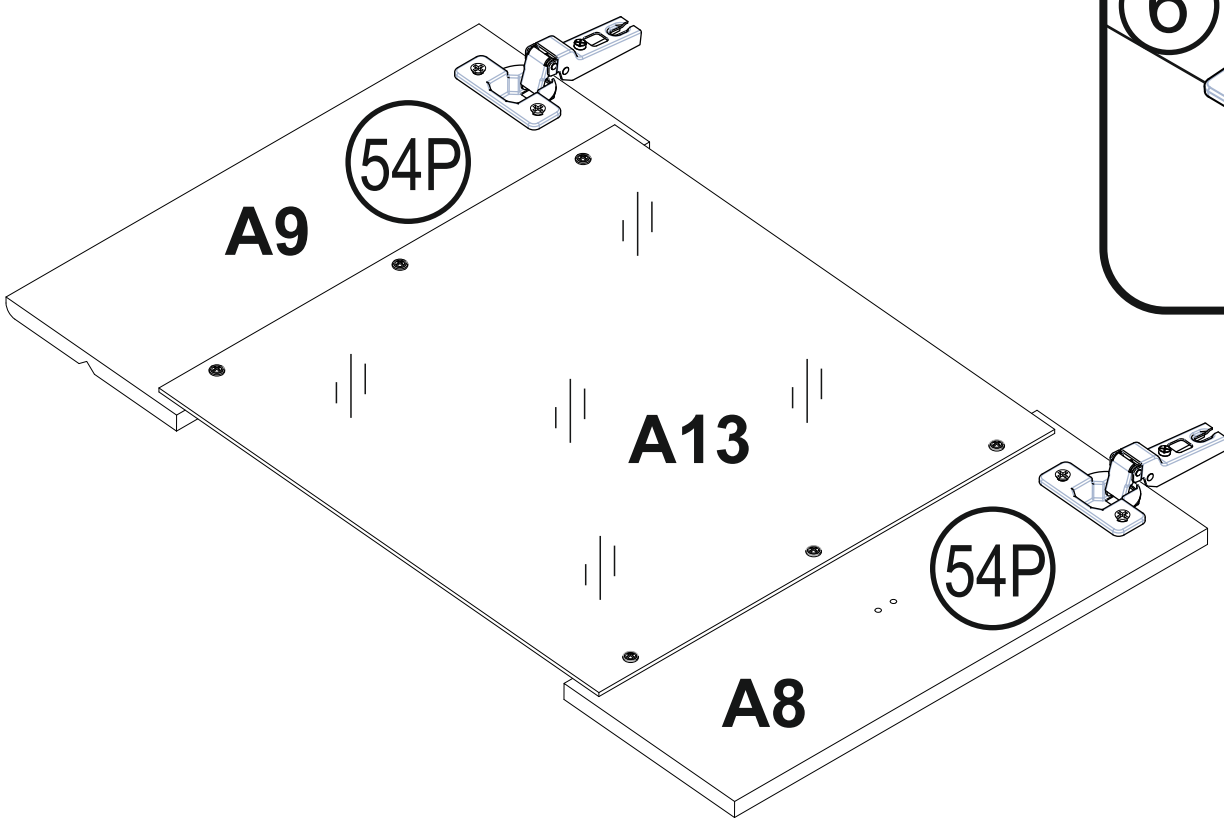
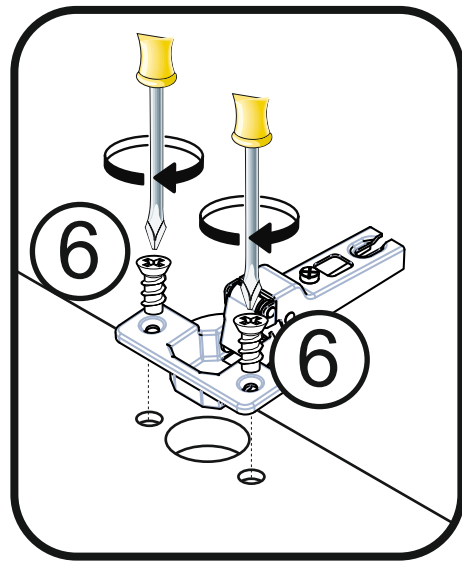
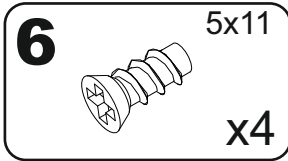
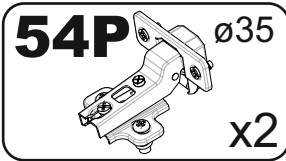

10

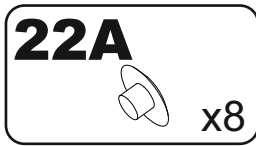
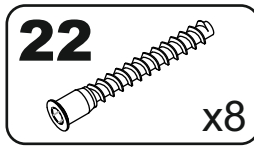

A1 1502x400

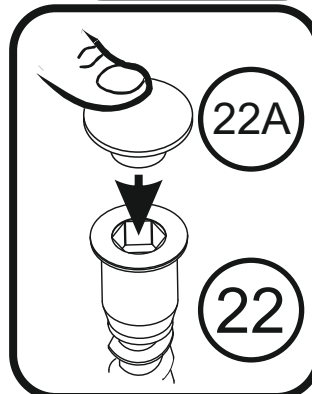
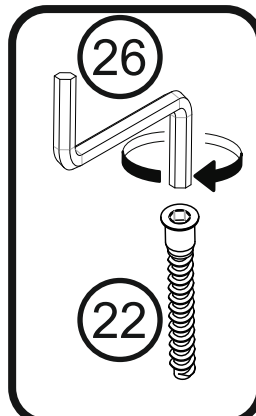
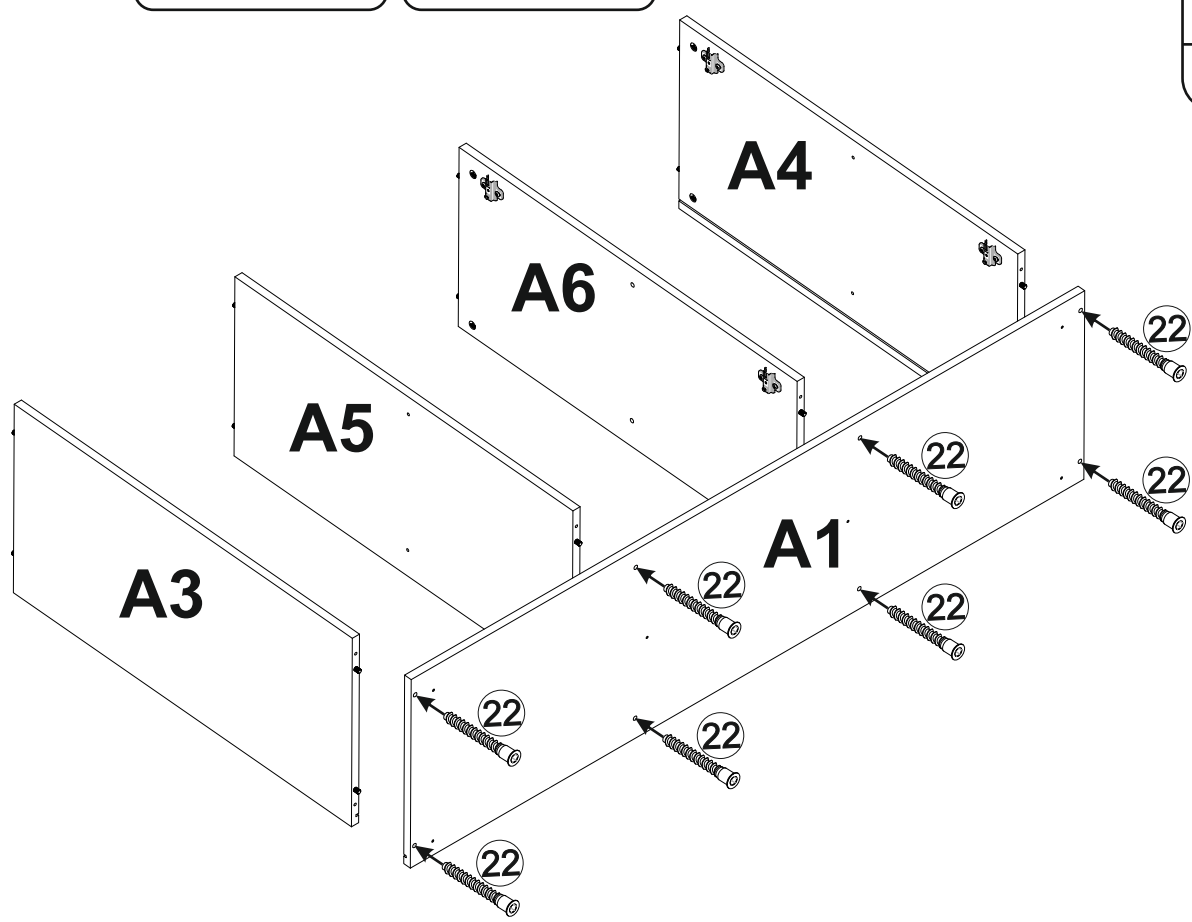
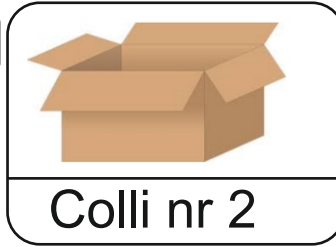



# 11

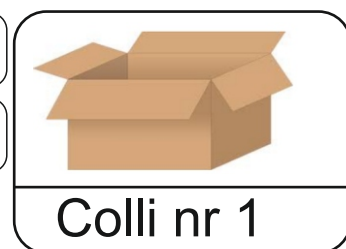
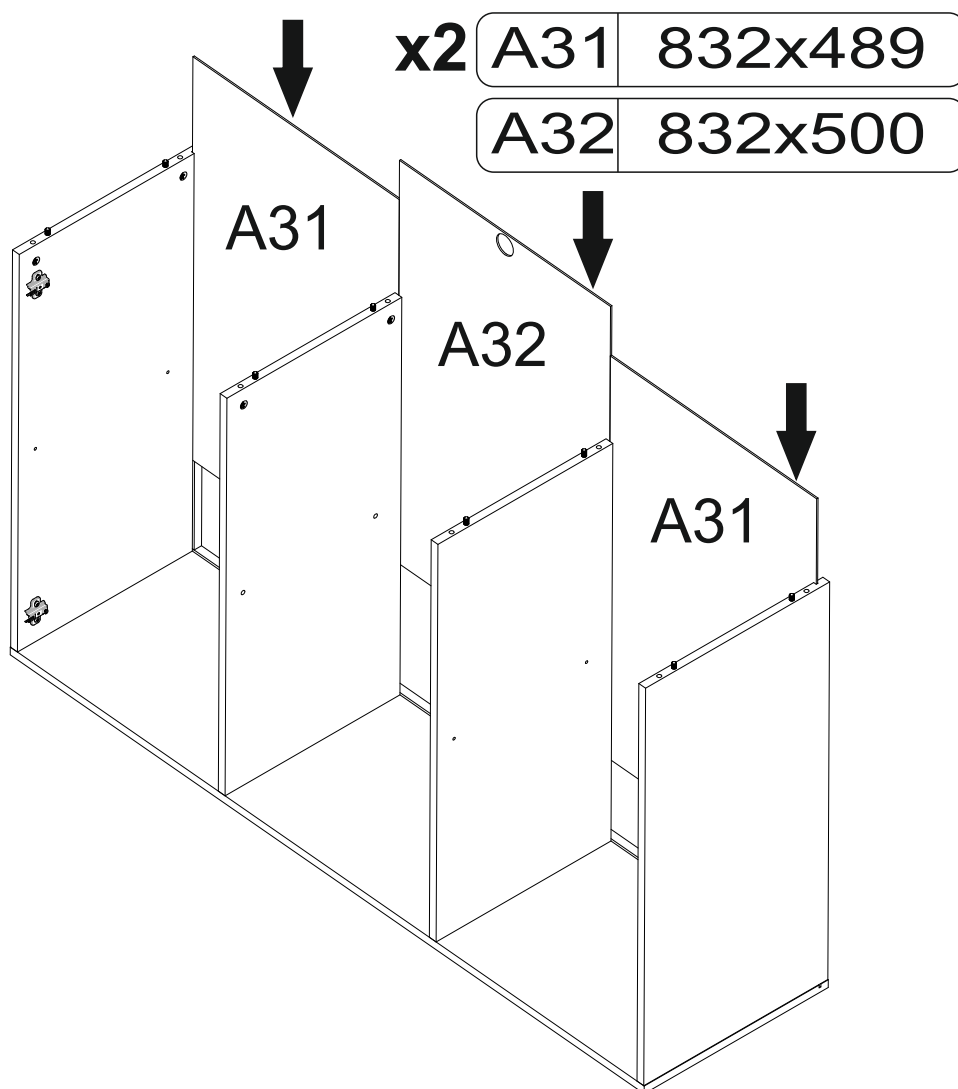

# 12

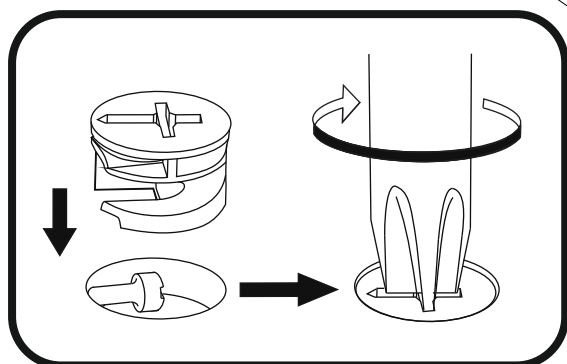
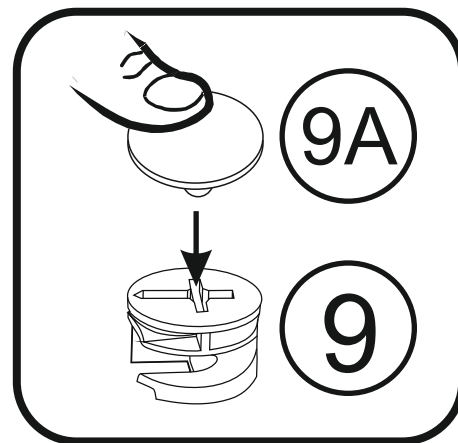
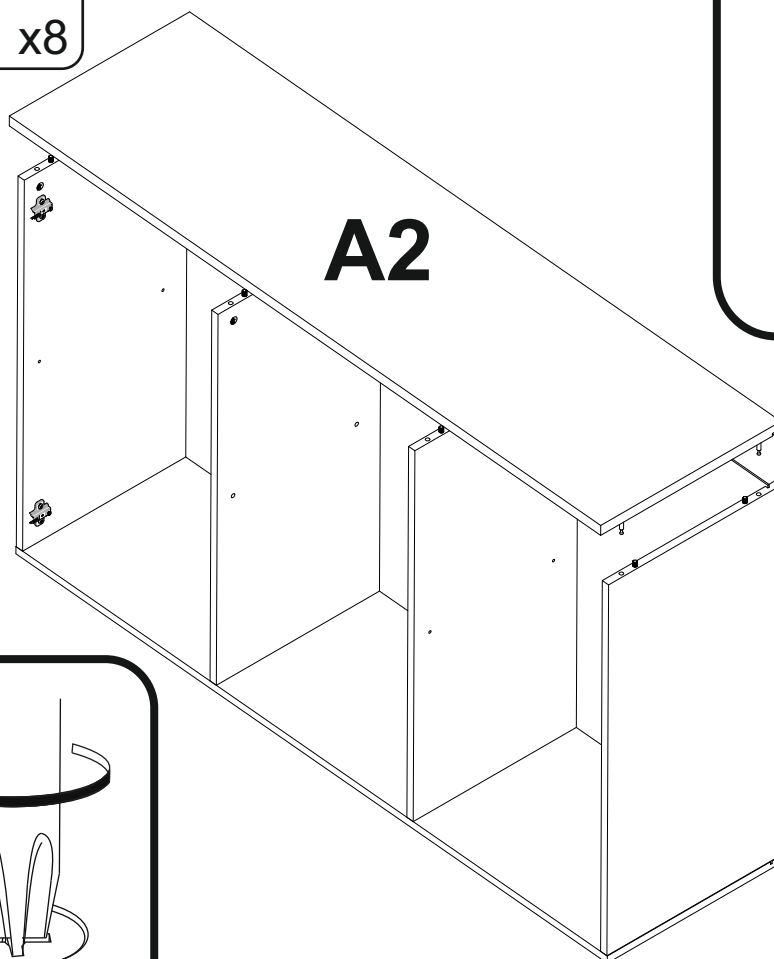
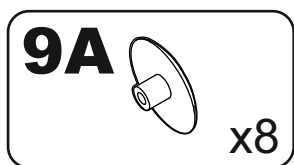

# 13

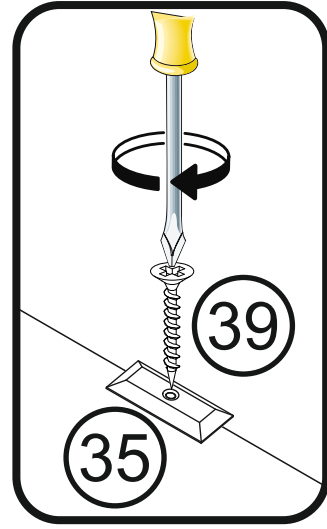
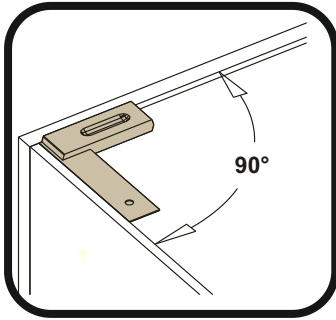
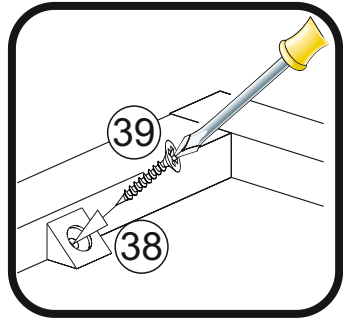
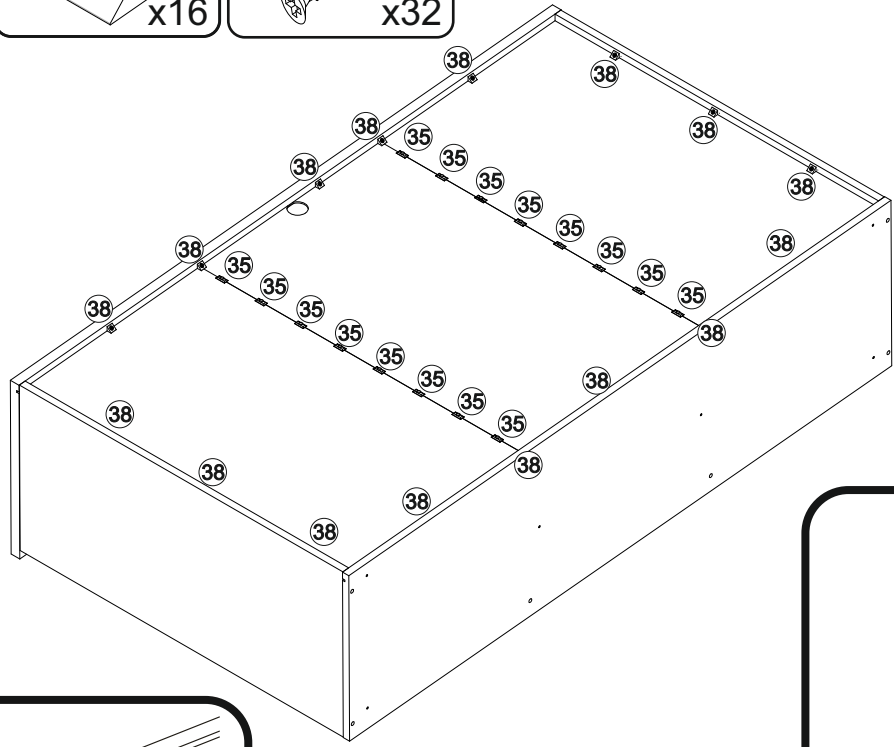
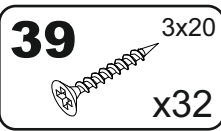
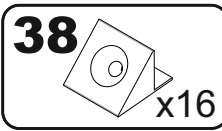
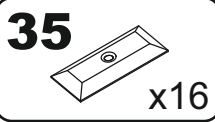

# 14

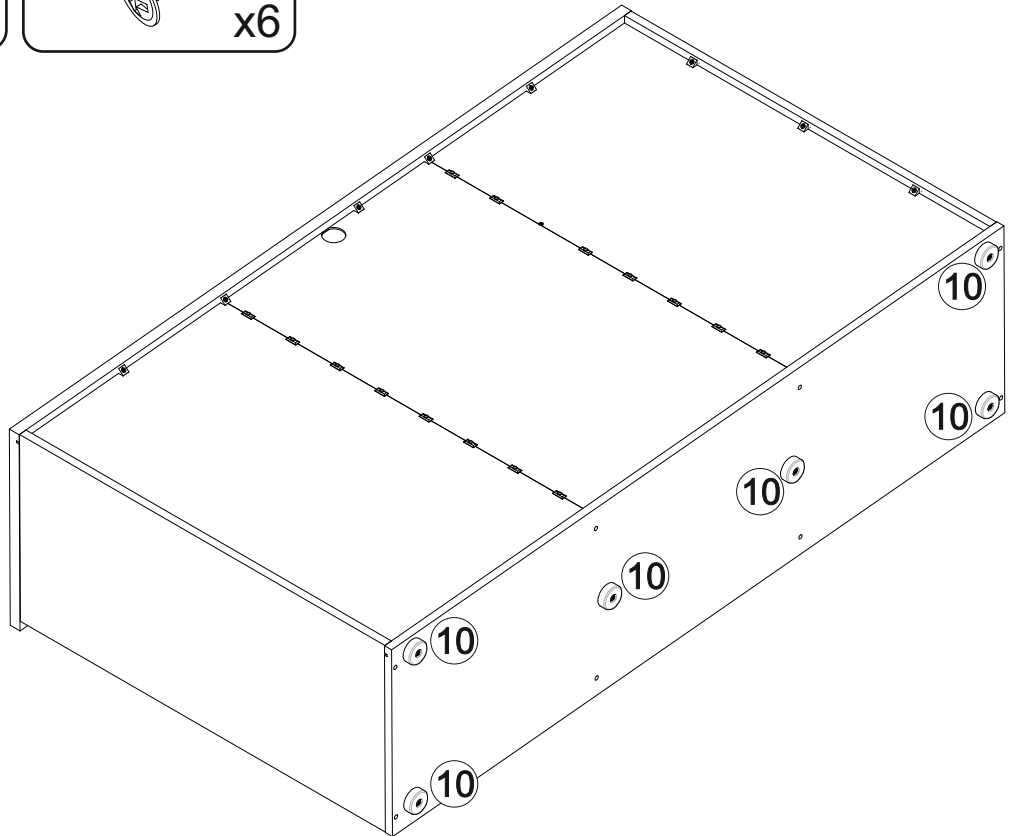
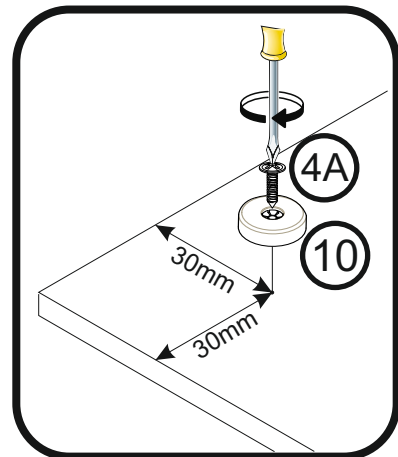
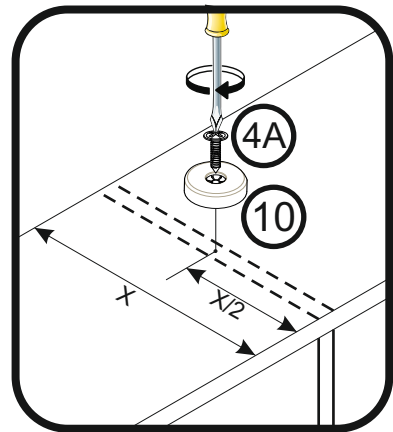
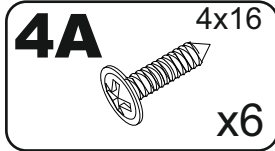
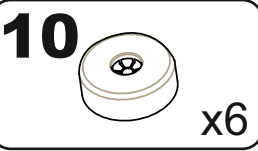

# 15

## 41

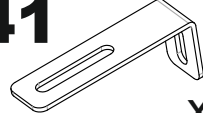

x1

## 80

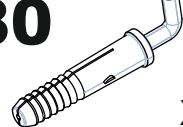

x1

## 4A

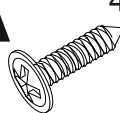

4x16

x1

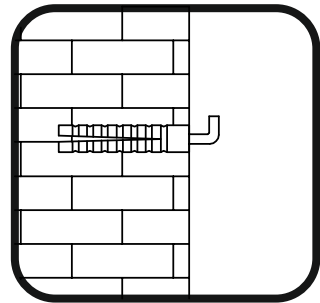
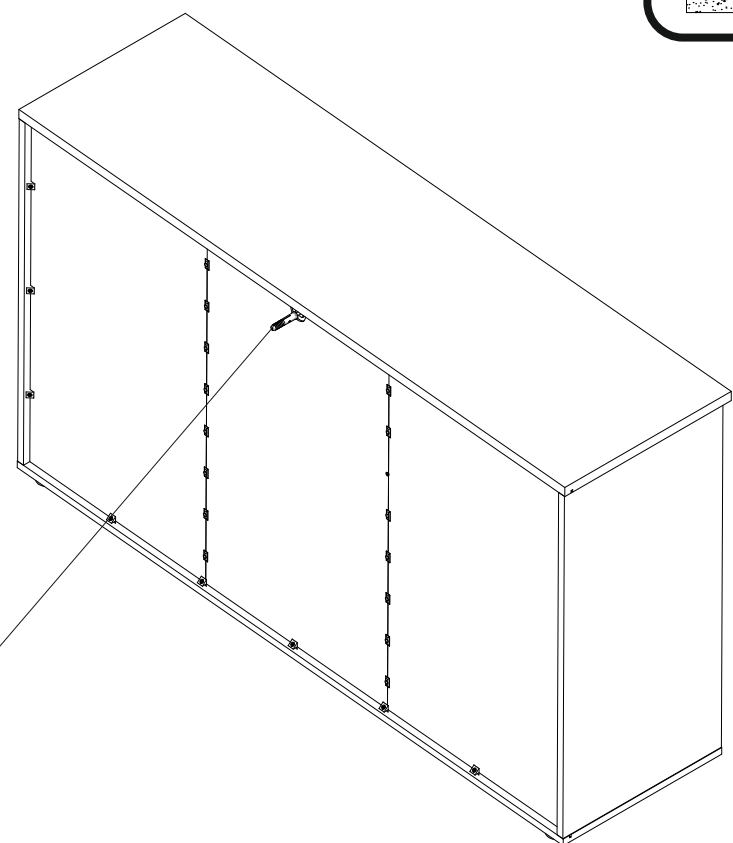
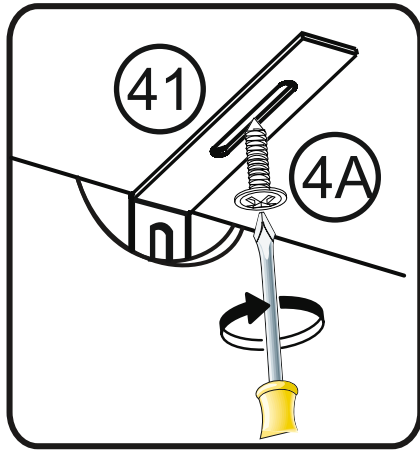
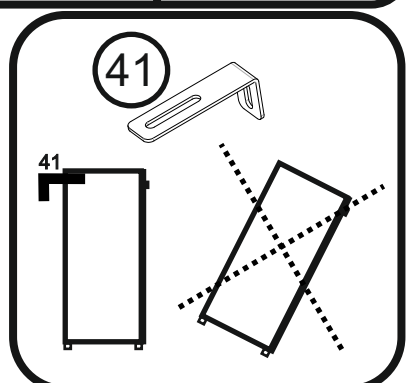
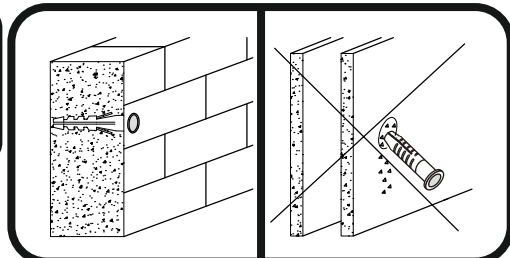

# 16

## 13

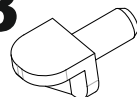

x8

## 14

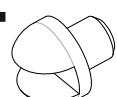

x4

x1

## A11

## 477x370

x2

## A12

## 476x370

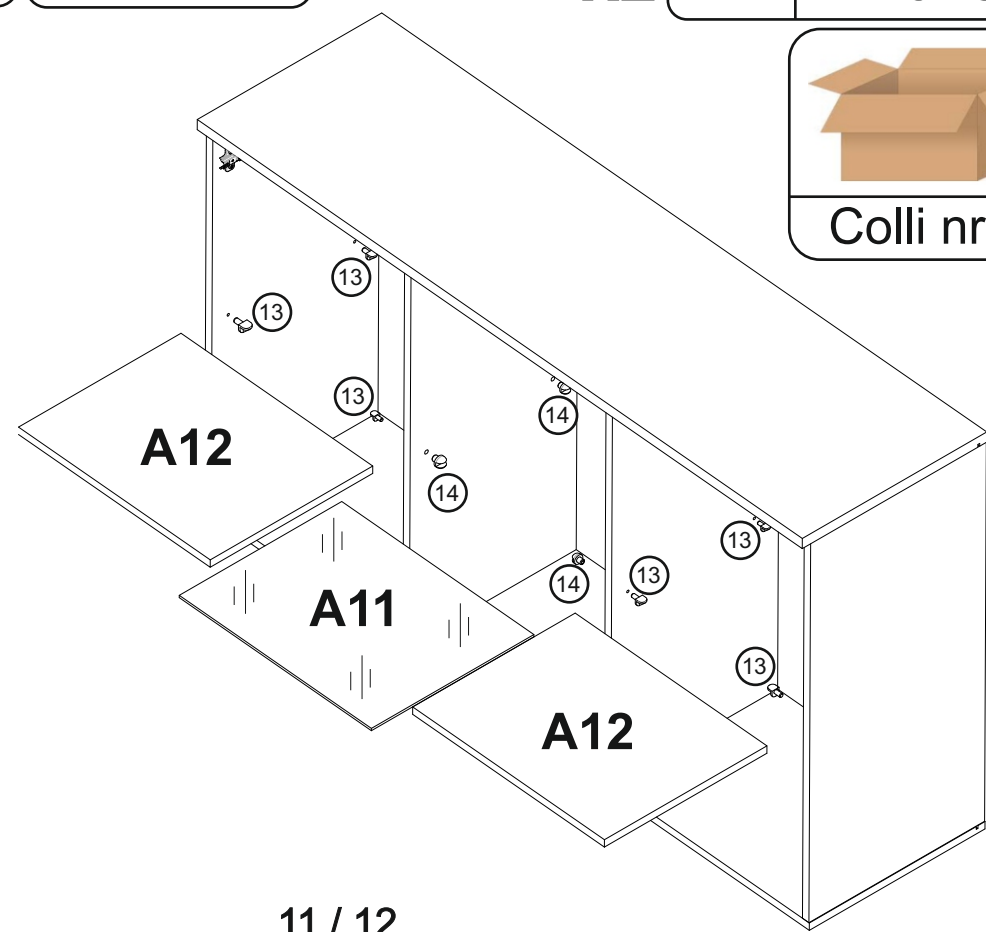
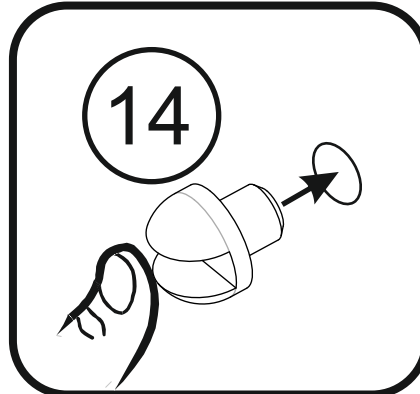
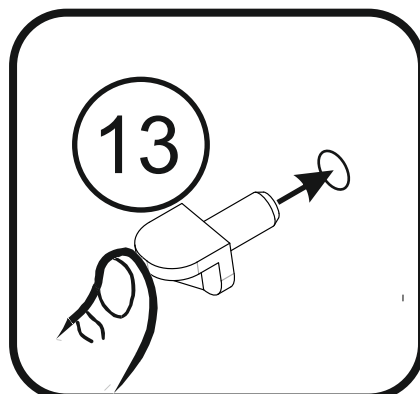
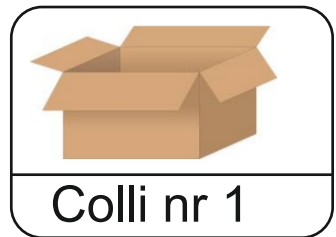

# 17

## 3

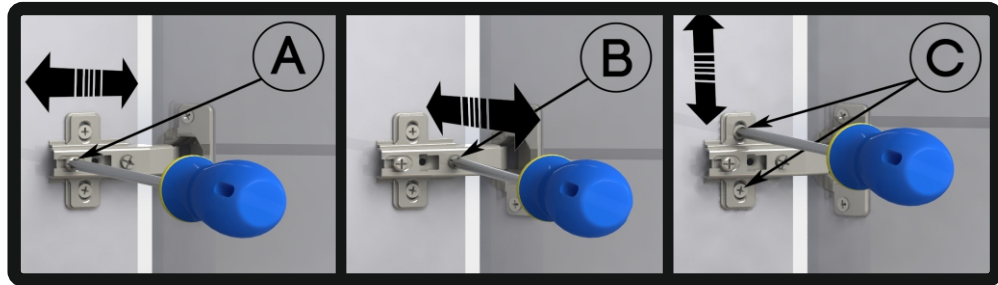
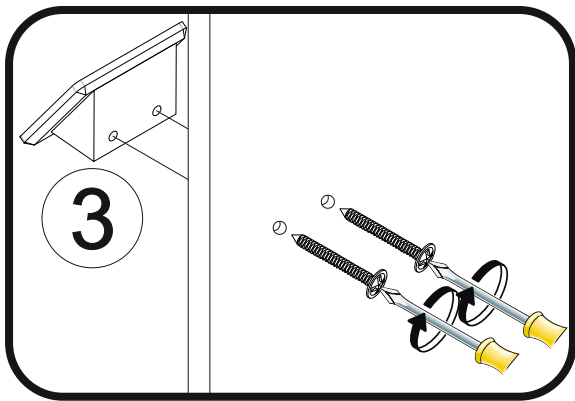
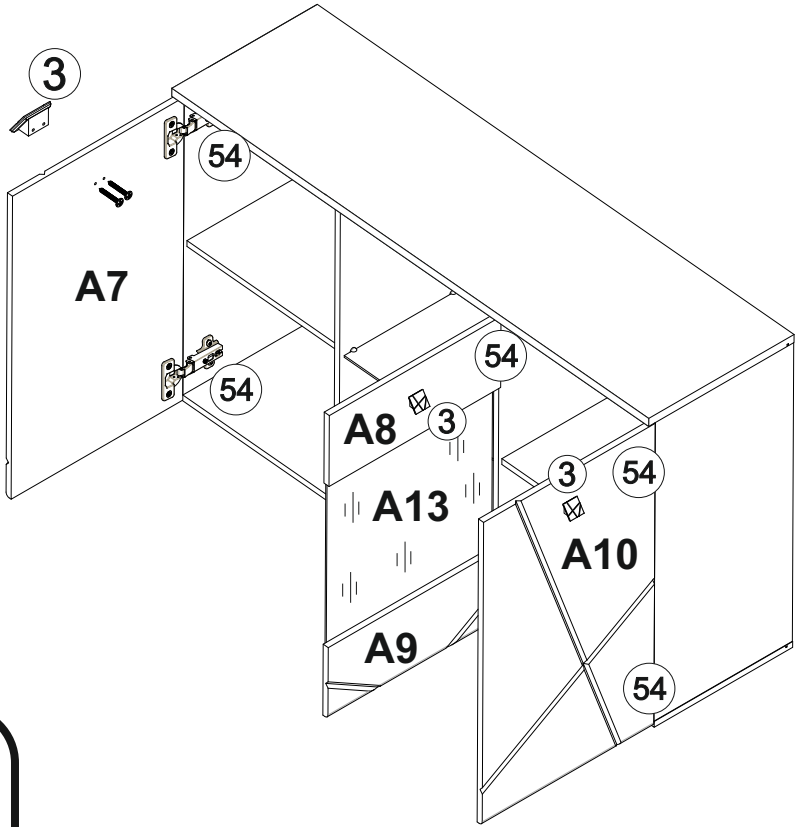
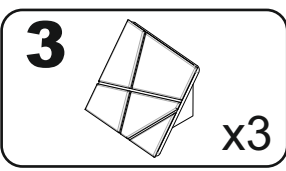

STEP 1	STEP 2
	<p data-bbox="842 1420 1102 1487"><b>7 DAYS</b></p>

